

ERGO LIFT 1000 ROLL

Ref. 067950



Pack 076792



The ERGO LIFT 1000 ROLL is capable of lifting and moving a 2.5 T vehicle, and operates solely on compressed air. The 4 support arms automatically lock, and are adjustable to adapt to all different types of chassis. With a lifting height of 95 cm, the user can work standing up, which reduces fatigue.

- Very compact: 10 cm above the ground in minimum position
- 95 cm maximum lifting height
- Complies with the EN 1493 standard (relating to vehicle lifts)
- Ideal for use in garages where space is limited
- Mobile and easily manoeuvrable with 4 optional wheels
- Load capacity of 2.5 T, factory tested to 3.8 T.



95 cm

Work in a standing position to help prevent musculoskeletal disorders (MSD).

Extremely stable and robust distortion-free scissor mechanism.



Supplied with 8 rubber pads

x4 4 cm

x4 6 cm

Handle for adjusting the automatic locking support arms (with or without charge).

The runner can be moved along the support arms to leave the lower section of the vehicle body completely accessible.

Universal maintenance-free hydropneumatic pump.

Hydraulic protection with an auto-locking scissor in the event of a hose rupture.

4 optional clip-on wheels

(ref. 076778) are available to convert the lift into a trolley. This allows the vehicle to be moved about the workshop with ease.







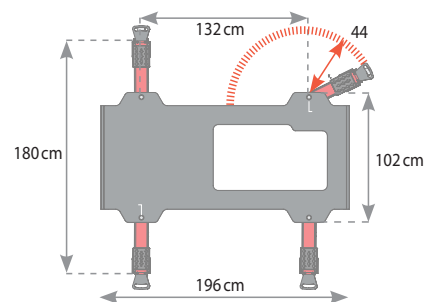

All axles are equipped with self-lubricating bronze bushings which makes them maintenance-free.

10 cm



Fits under all vehicles.

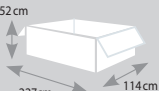

							IP			
2.5 T	minimum	maximum	1 500 kg	2 500 kg	max.	260 cm	IP54	kg	52 cm 227 cm 114 cm	
	10 cm	95 cm	45 sec.	60 sec.	8 bar			400	430 kg	